

MICRO4000[®]NET[™]

Web Width Monitor System

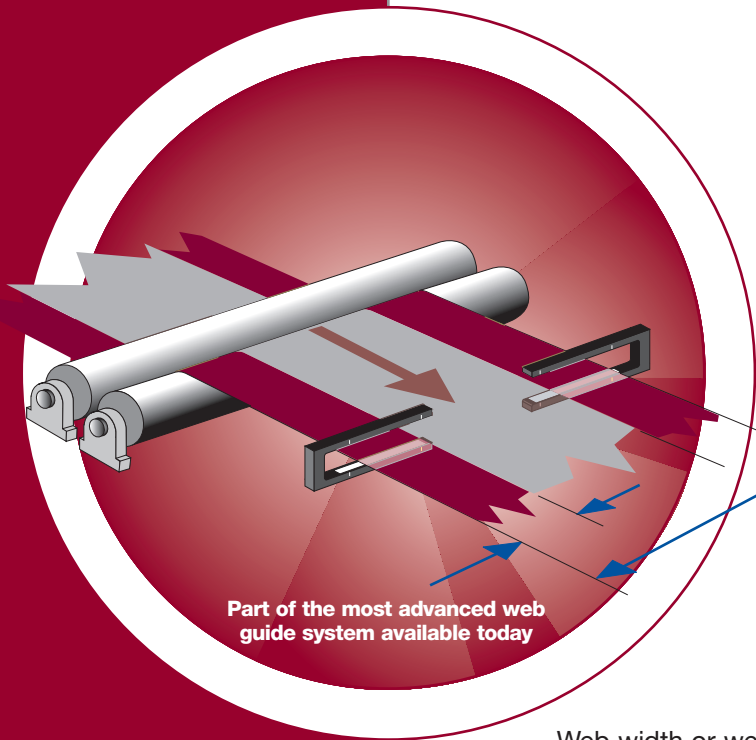

Part of the most advanced web guide system available today

The Micro 4000NET Web Width Monitor System, with no moving parts, sets a standard for accuracy and reliability.

Web width or web edge position can be critical in converting applications. AccuWeb's Web Width Monitor system excels at making these measurements for both data acquisition and process control. The system uses patented WideArray[™] edge detectors and a Micro 4000NET controller to make accurate web width and position measurements.

Change web widths up to 36.8" (934mm) without moving the edge detectors

- **Eliminate Motorized Positioners** — WideArray edge detectors provide up to 18.4" (467mm) detection range per side, which eliminates the need for motorized detector positioners.
- **Accurate and Reliable** — Dynamically compensated edge detectors continuously adapt to changing environmental conditions and build-up of contaminants on the sensors. Eliminates maintenance headaches caused by constant cleaning and recalibration.
- **Any Web Material** — WideArray[™] ultrasonic and infrared edge detectors can sense virtually any material - paper, film, foil, nonwovens, or mesh.
- **Operator Friendly** — The compact 3-button remote station can be mounted virtually anywhere. Simple menus allow quick set-up of all tolerance and calibration settings.
- **Fast Changeover** — The job recipe function allows the operator to store and instantly recall calibration and alarm settings for up to 25 products and processes.
- **Alarm Outputs** — The controller has six digital outputs that can be programmed to trigger alarms when the web width or position is out-of-tolerance.
- **Network Friendly** — Optional fieldbus adapters easily interface with all popular fieldbus protocols, including CANopen, ControlNet[™], DeviceNet[™], Ethernet/IP, Modbus Plus, Modbus TCP, and Profibus[®]-DP protocols.

Remote station



Dynamically compensated edge detectors

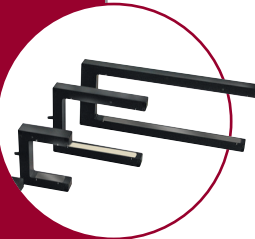

Optional fieldbus adapter

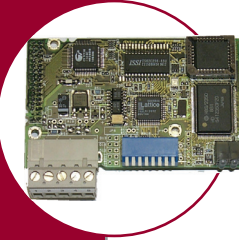

Compatible with the Micro 4000NET controller



Manufactured in the United States
under Patents #5,834,877 and #5,274,573

AccuWeb, Inc.
www.accuweb.com

The Micro 4000NET can handle EVERY web guide application
Specifications

Resolution: ±0.020" (±0.51mm)

System Features:

- Remote station with touch pad and LCD display
- User selectable English or Metric units
- Independent minimum and maximum web width alarms
- Independent left and right web out-of-center alarms
- Job recipe function stores and recalls calibration and alarm settings for up to 25 products and processes
- Optically-isolated alarm outputs
- ±10VDC or 0-10VDC analog output indicates web width or position

Enclosure:

- IP65 rated
- Cam-locked door with double-bit insert key
- Hazardous, stainless steel, and custom designs available
- Chassis mount available

Temperature:

- 30°F (0°C) – 125°F (52°C)

Options:

- CANopen, ControlNet™, DeviceNet™, Ethernet/IP, Modbus Plus, Modbus TCP, and Profibus®-DP protocols
- Web guiding
- Oscillation
- Randomizing
- Master/Follower web guiding
- Chaser/Slave web guiding
- Class I, Division 1 hazardous environment
- Wash-down

Micro 4000NET Dimensions

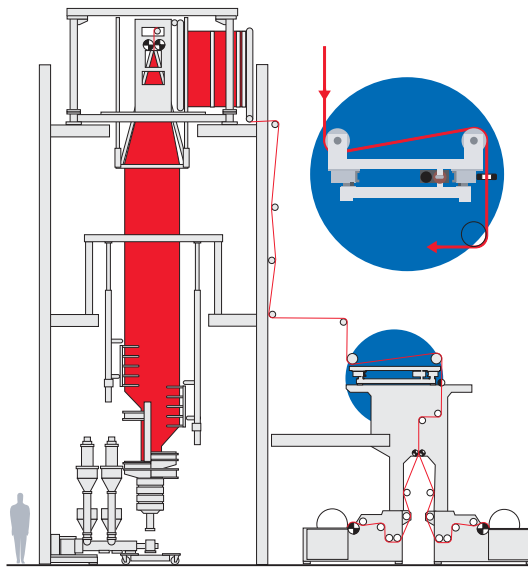
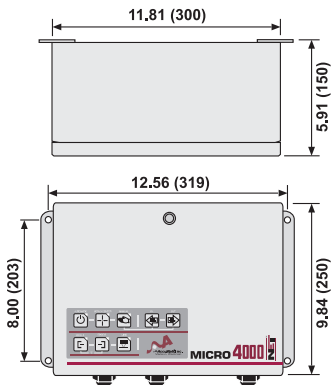

Blown or Flat Film Extruders

Using the WideArray edge detection system in Blown Film or Flat Film extruders has several advantages. It can oscillate the web, measure web width, monitor edge position, or position one web relative to another. The application shown above is guiding the web into the slitter and windup, while simultaneously controlling bubble pressure to keep the lay-flat web width within preset limits.

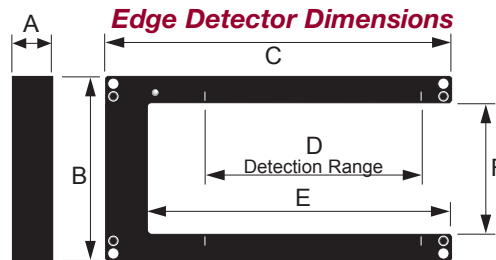

Model	Dimensions - Inches (mm)					
	A	B	C	D	E	F
1.5x3.75	1.25 (32)	3.00 (76)	4.56 (116)	1.20 (30)	3.81 (97)	1.50 (38)
1.5x5	1.25 (32)	3.00 (76)	5.75 (146)	2.40 (61)	5.00 (127)	1.50 (38)
4x3.75	1.25 (32)	5.50 (140)	4.56 (116)	1.20 (30)	3.81 (97)	4.00 (102)
4x5	1.25 (32)	5.50 (140)	5.75 (146)	2.40 (61)	5.00 (127)	4.00 (102)
4x9	1.25 (32)	5.50 (140)	10.25 (260)	6.40 (163)	9.00 (229)	4.00 (102)
4x14	1.25 (32)	5.50 (140)	15.06 (383)	11.20 (284)	13.81 (351)	4.00 (102)
4x21	1.31 (33)	5.75 (146)	22.50 (572)	18.40 (467)	21.13 (537)	4.00 (102)

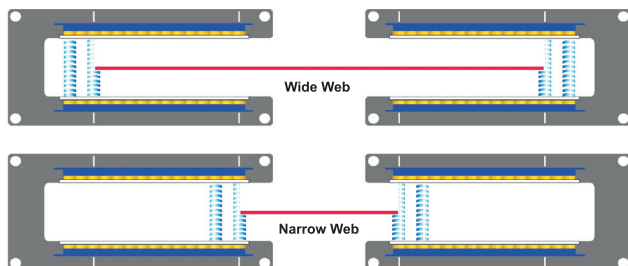

Toll free: (888) 422-2893 • Web site: www.accuweb.com

You'll always get more value from AccuWeb

- System allows simultaneous web width monitoring and web guiding.
- Not sensitive to vertical motion or web flutter.
- Hazardous Duty — Optional provisions for use in Class I Division 1 hazardous environment. Note: Control enclosure must be located outside of the hazardous environment.
- Ideal for blown or flat film extruders.
- Other applications include:
 - Multiple-web sheeters
 - Laminators
 - Web-weave monitoring

World Headquarters

P.O. Box 7816
 Madison, WI 53707 U.S.A.

Phone: (608) 223-0625
 Fax: (608) 223-0074

European Sales and Support

Formanguieres 87
 CH-1782 Belfaux/Switzerland

Phone: +41 26 475 5028
 Fax: +41 26 475 5025